

RUBBER ACCESSORIES FOR MORRIS MINORS

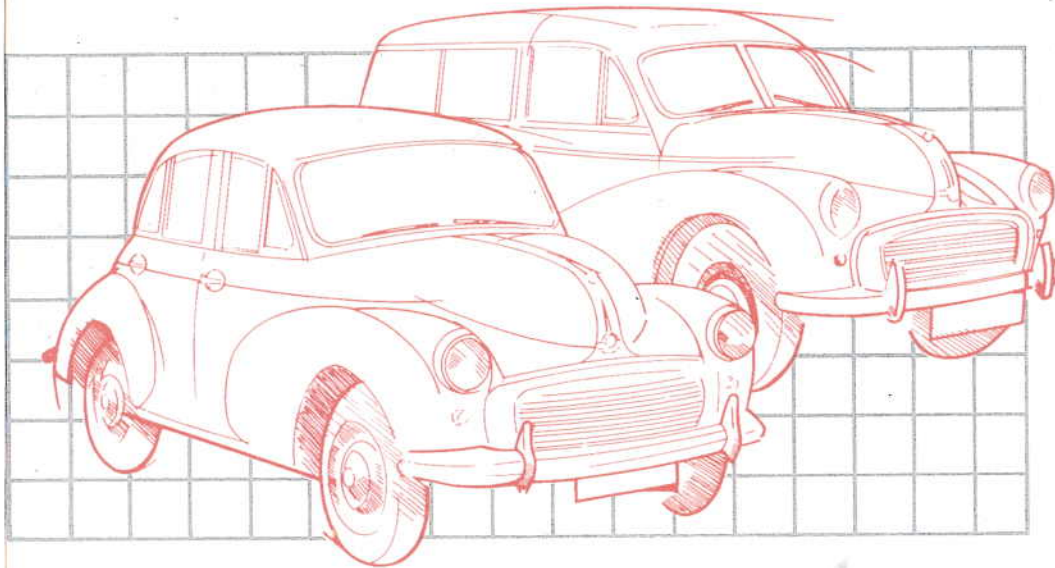

A WIDE VARIETY OF EXTRUDED
RUBBER PROFILES



MOULDED RUBBER PARTS AND
P.V.C. EXTRUSIONS



RE-RUBBERISING OF METAL PARTS
AND WASHER FABRICATION



RUBBER
PRODUCTS & MOULDINGS LTD

FACTORY, SHOWROOM & SALES: 16th AVENUE, BOX 38, MATLAND, 7405
TEL (021) 593-2110 TELEFAX (021) 593-4535



MORRIS MINOR

EXTRUSIONS

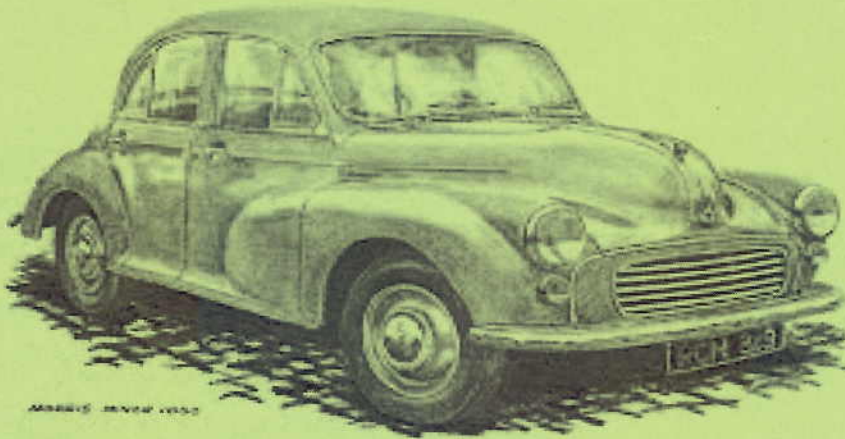

BY
RUBBER PRODUCTS AND MOULDINGS (PTY)LTD.



021-593 2110





sales@rpm.co.za

WWW.RPM.CO.ZA

**RUBBER
ACCESSORIES FOR
MORRIS MINOR**

PAGE 1

EXTRUSIONS

REFERENCE		DETAILS
CODE 400 DIE: 895		SEALING STRIP A-FRAME WINDOW TO BODY REAR (NARROW)
CODE 401 DIE: 896		SEALING STRIP A-FRAME WINDOW TO BODY FRONT (WIDE)
CODE 91300 DIE: 913		TWO DOOR REAR SIDE WINDOW RUBBER
CODE 403 DIE: 914 IRS 1652		QUARTERLIGHT VERTICAL WINDOW SEAL

RUBBER
PRODUCTS & MOULDINGS (PTY) LTD.







P.O. BOX 38, MAITLAND
 TEL: (021) 593-2110
 FAX: (021) 593-4535

**RUBBER
ACCESSORIES FOR
MORRIS MINOR**

PAGE 2

EXTRUSIONS

REFERENCE		DETAILS
CODE 404 DIE: 915 / 1031		REAR WINDOW SEAL
CODE 405 IRS 1586 EP DIE: 922		BOOT LID SEAL
CODE 406 DIE: 927		REAR QUARTERLIGHT SEAL (4 DOOR ONLY)
CODE 407 DIE: 937 IRS 1666 EP		BONNET LID SEAL





RUBBER
 PRODUCTS & MOULDINGS (PTY) LTD.



P.O. BOX 38, MAITLAND
 TEL: (021) 593-2110
 FAX: (021) 593-4535

**RUBBER
ACCESSORIES FOR
MORRIS MINOR**

EXTRUSIONS

REFERENCE		DETAILS
<p>CODE 408 DIE: 938</p>		<p>SEAL FOR UNDER THE DOORS</p>
<p>CODE 409 DIE: 952</p>		<p>FRONT WINDSCREEN RUBBER</p>
<p>CODE 410</p>		<p>DOOR SEAL</p>
<p>CODE 433 DIE: 1012 IRS 1662 EP</p>		<p>FRONT GRILLE TO FENDER RUBBER EXTRUSION</p>

RUBBER
PRODUCTS & MOULDINGS (PTY) LTD.







P.O. BOX 38, MAITLAND
TEL: (021) 593-2110
FAX: (021) 593-4535

**RUBBER
ACCESSORIES FOR
MORRIS MINOR**

PAGE 4

EXTRUSIONS

REFERENCE		DETAILS
CODE 64600 DIE: 646		BOOT SEAL
CODE 65400 DIE: 654		BONNET SEAL
CODE 69800 DIE: 698		MORRIS TRAVELLER ROOF SEAL
CODE 72000 DIE: 720		TRIUMPH BULKHEAD SEAL

RUBBER
PRODUCTS & MOULDINGS (PTY) LTD.







P.O. BOX 38, MAITLAND
TEL: (021) 593-2110
FAX: (021) 593-4535

**RUBBER
ACCESSORIES FOR
MORRIS MINOR**

PAGE 5

EXTRUSIONS

REFERENCE		DETAILS
CODE 93300 DIE: 933		MG WINDSCREEN SEAL
CODE 112500 DIE: 1125		QUARTERLIGHT DOOR SEAL
CODE 41301 DIE: P16		FENDER TO BODY PVC SEAL 24mm
CODE 41401 DIE: P49		FENDER TO BODY PVC SEAL 35mm

RUBBER
PRODUCTS & MOULDINGS (PTY) LTD.



P.O. BOX 38, MAITLAND
TEL: (021) 593-2110
FAX: (021) 593-4535

MORRIS MINOR

GENERAL MOULDINGS

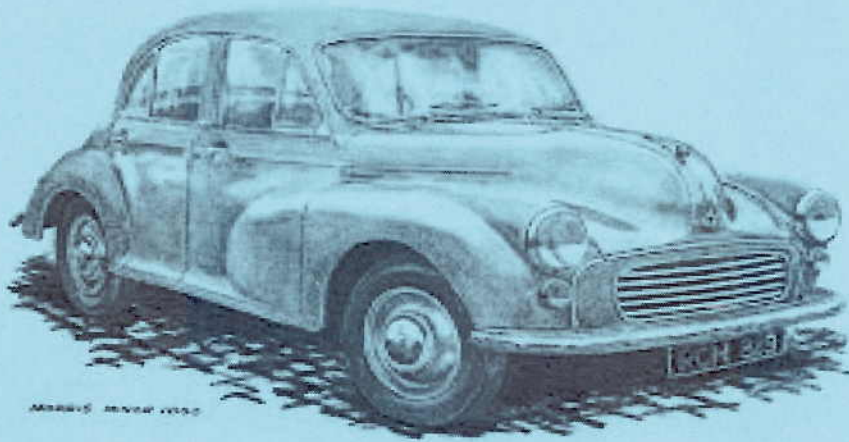

BY
RUBBER PRODUCTS AND MOULDINGS (PTY)LTD.



021-593 2110

sales@rpm.co.za

WWW.RPM.CO.ZA

**RUBBER
ACCESSORIES FOR
MORRIS MINOR**

PAGE 6

MOULDINGS

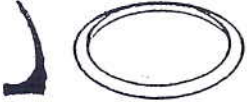
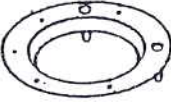
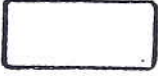
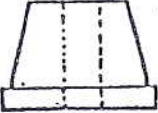
REFERENCE		DETAILS
CODE 395		HEADLIGHT SEAL OUTER CHROME TRIM STRIP (OPTIONAL)
CODE 396		MAIN HEADLIGHT SEAL (BODY)
CODE 411		SIDE INSPECTION COVER GASKET
CODE 412		UPPER FRONT SUSPENSION BUSH

RUBBER
PRODUCTS & MOULDINGS (PTY) LTD.



P.O. BOX 38, MAITLAND
TEL: (021) 593-2110
FAX: (021) 593-4535

**RUBBER
ACCESSORIES FOR
MORRIS MINOR**

PAGE 7

MOULDINGS

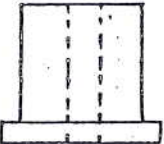
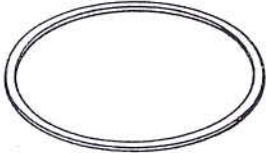
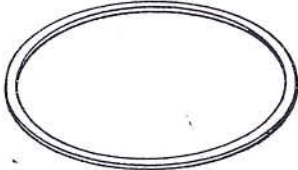
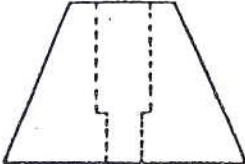
REFERENCE		DETAILS
CODE 415		LOWER FRONT SUSPENSION BUSH
CODE 416		TIMING CHAIN TENSIONER 948cc
CODE 417		TIMING CHAIN TENSIONER 1098cc
CODE 418		RUBBER BONNET STOP SQUARE

RUBBER
PRODUCTS & MOULDINGS (PTY) LTD.







P.O. BOX 38, MAITLAND
TEL: (021) 593-2110
FAX: (021) 593-4535

**RUBBER
ACCESSORIES FOR
MORRIS MINOR**

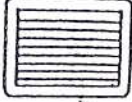
PAGE 8

MOULDINGS

REFERENCE		DETAILS
CODE 419		RUBBER ACCELERATOR PEDAL PAD
CODE 420		RUBBER BRAKE & CLUTCH PEDAL PAD
CODE 421		RUBBER BUFFER FOR ENGINE STEADY ARM
FACTORY REFURB		ENGINE MOUNTING



RUBBER
PRODUCTS & MOULDINGS (PTY) LTD.



P.O. BOX 38, MAITLAND
TEL: (021) 593-2110
FAX: (021) 593-4535

**RUBBER
ACCESSORIES FOR
MORRIS MINOR**

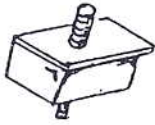
MOULDINGS

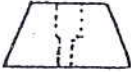
REFERENCE		DETAILS
FACTORY REFURB		GEARBOX MOUNTING
FACTORY REFURB		REAR SHOCK ABSORBER ARM LINK
FACTORY REFURB		REBOUND CHECK BRACKET FRONT SHOCK ABSORBER
CODE 427	 (Use code:80 Doorstop)	DASH BUFFER

RUBBER
PRODUCTS & MOULDINGS (PTY) LTD.





P.O. BOX 38, MAITLAND
TEL: (021) 593-2110
FAX: (021) 593-4535

**RUBBER
ACCESSORIES FOR
MORRIS MINOR**

PAGE 10

MOULDINGS

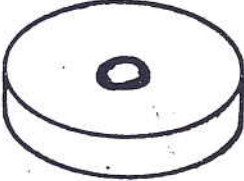
REFERENCE		DETAILS
CODE 428		TAPPET COVER GROMMET
CODE 429	 (Use code: 123 Bush)	CHASSIS TO GEARBOX RELAY SHAFT RUBBER BUSH (Use old bronze insert)
CODE 431		STABILIZER ARM BUSH

RUBBER
PRODUCTS & MOULDINGS (PTY) LTD.





P.O. BOX 38, MAITLAND
TEL: (021) 593-2110
FAX: (021) 593-4535

**RUBBER
ACCESSORIES FOR
MORRIS MINOR**

PAGE 11

MOULDINGS

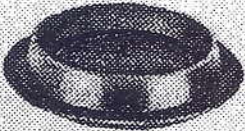
REFERENCE		DETAILS
CODE 434		FRONT SWIVEL PIN RUBBER TOP
CODE 435		REAR BLADE SPRING RUBBER PAD
CODE 436		WINDSCREEN WIPER MOTOR MOUNTING GROMMET
CODE 42		BLIND GROMMET FOR HOLE IN FLOORBOARD OVER STEERING RACK GREASE NIPPLE

RUBBER
PRODUCTS & MOULDINGS (PTY) LTD.





P.O. BOX 38, MAITLAND
TEL: (021) 593-2110
FAX: (021) 593-4535

**RUBBER
ACCESSORIES FOR
MORRIS MINOR**

PAGE 12

MOULDINGS

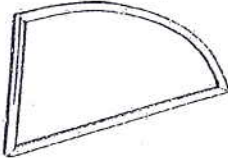
REFERENCE		DETAILS
CODE 280		BLIND GROMMET FOR HOLE IN FLOORBOARD OVER GEARBOX FILLER PLUG
CODE 32		GREASE AND BRAKE NIPPLE COVERS
CODE 402		TWO DOOR REAR SIDE COMPLETE PRE-VULCANISED GASKET

RUBBER
PRODUCTS & MOULDINGS (PTY) LTD.



P.O. BOX 38, MAITLAND
TEL: (021) 593-2110
FAX: (021) 593-4535

MORRIS MINOR

MOULDED SPONGE PROFILES

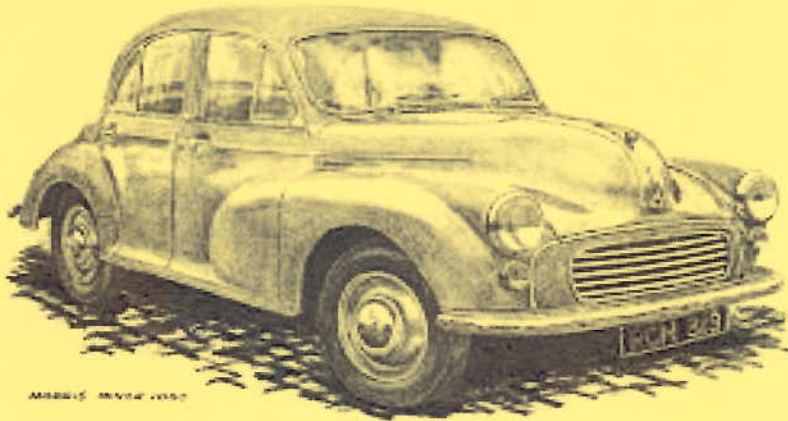

BY
RUBBER PRODUCTS AND MOULDINGS (PTY)LTD.







021-593 2110

sales@rpm.co.za

RUBBER ACCESSORIES

PAGE 13

MOULDED SPONGE PROFILES

REFERENCE	PROFILE
<u>RPM.40</u> CODE 539	
<u>RPM.16</u> CODE 177	
<u>RPM.24</u> CODE 180	
<u>RPM.28</u> CODE 182	

RUBBER
PRODUCTS & MOULDINGS (PTY) LTD.







P.O. BOX 38, MAITLAND
TEL: (021) 593-2110
FAX: (021) 593-4535

RUBBER ACCESSORIES

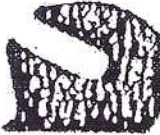
PAGE 14

MOULDED SPONGE PROFILES

REFERENCE	PROFILE
<u>RPM.30</u> CODE 347	
<u>RPM.32</u> CODE 360	
<u>RPM.34</u> CODE 373	
<u>RPM.35</u> CODE 374	

RUBBER
PRODUCTS & MOULDINGS (PTY) LTD.



P.O. BOX 38, MAITLAND
TEL: (021) 593-2110
FAX: (021) 593-4535